

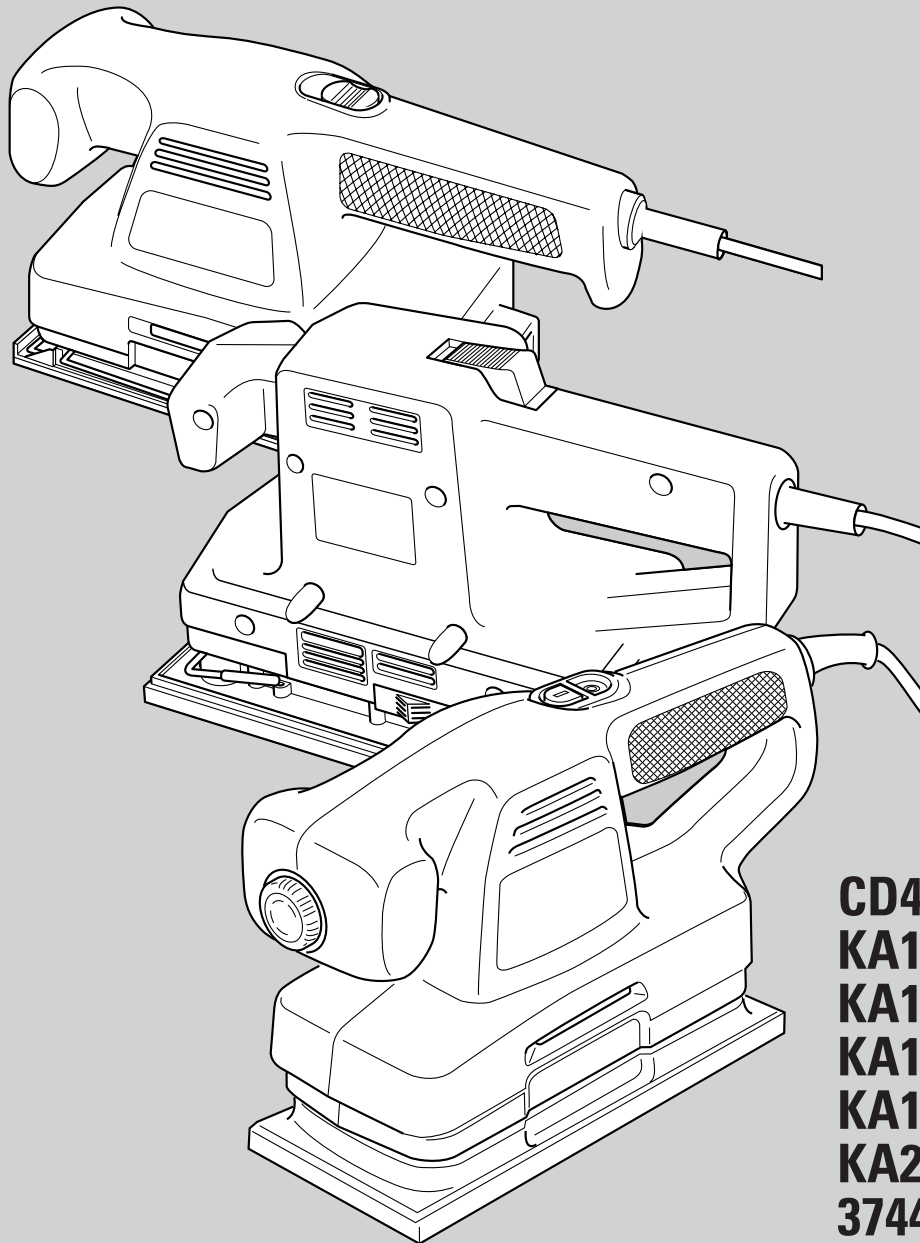

 **BLACK &  
DECKER®**



**CD400  
KA175  
KA180  
KA185  
KA186  
KA273  
374455**





## **Congratulations!**

### *On the purchase of your Black & Decker sander.*

To ensure the best results from your sander please read these safety and usage instructions carefully.

If you have any questions or queries after reading this user manual please do not hesitate to call our Service and Information Centre, whose number you will find towards the back of this user manual, or one of our Authorised Repair Agents. A list of these Agents and further information is available on the Internet at [www.2helpU.com](http://www.2helpU.com).





# Contents

**Page 4** Safety instructions  
Additional precautions to take when sanding paint and MDF

**Page 5** Personal safety  
Environmental safety  
Cleaning and disposal  
Double insulation  
Electrical safety  
Mains plug replacement

**Page 6** Extension cables  
Unwanted tools and the environment  
The Black & Decker guarantee  
After sales service for your Black & Decker product  
Our after sales service policy  
Accessories  
Technical data  
Features

**Page 7** Preparing your sander  
Fitting the sandpaper  
Dust extraction

**Page 8** Variable speed  
Operating your sander  
Handy hints  
Tool care  
EC declaration of conformity  
Black & Decker phone numbers and addresses  
Guarantee card for Australia and New Zealand



# Sanders user manual

## SAFETY INSTRUCTIONS

**Warning!** When using electric tools, the following basic safety precautions should always be taken to reduce the risk of fire, electric shock and personal injury. Read all these instructions before attempting to operate the product and save this booklet.

### For safe operation:

- **Keep the work area clean.** Cluttered areas and benches invite injuries.
- **Consider the work area environment.** Do not expose the power tool to rain and do not use in damp or wet locations. Keep the work area well lit. Do not use the power tool where there is a risk to cause fire or explosion.
- **Guard against electric shock.** Avoid body contact, where possible, with earthed or grounded surfaces (e.g. pipes, radiators, ranges and refrigerators).
- **Keep children away.** Do not let visitors touch the tool or extension cord. All visitors should be kept away from the work area.
- **Store idle tools.** When not in use, tools should be stored in a dry, high or locked place, out of reach of children.
- **Do not force the tool.** It will do the job better and more safely at the rate for which it was intended.
- **Use the right tool.** Do not force small tools or attachments to do the job of a heavy duty tool. Do not use the tool for purposes not intended; for example, do not use a circular saw to cut tree limbs or logs.
- **Dress properly.** Do not wear loose clothing or jewellery as they can be caught in moving parts. Rubber gloves and non-skid footwear are recommended when working outdoors. Wear protective hair covering to contain long hair.
- **Use safety glasses.** Use a face or dust mask as well, if the operation is dusty or if the tool is being used in enclosed spaces.
- **Connecting dust extraction equipment.** If devices are provided for the connection of dust extraction and collection ensure these are connected and properly used, especially in confined areas.
- **Do not abuse the cord.** Never carry the tool by its cord or yank it to disconnect it from the socket. Keep the cord away from heat, oil and sharp edges.
- **Secure the work.** Use clamps or a vice to hold the work. It is safer than using a hand and it frees both hands to operate the tool.
- **Do not overreach.** Keep proper footing and balance at all times.
- **Maintain the tool with care.** Keep a cutting tool sharp and clean for better and safer performance. Follow the instructions for lubricating and changing accessories. Inspect the tools cord periodically and, if damaged, have repaired by an authorised service agent. Inspect the extension cord periodically and replace if damaged. Keep the handles dry, clean and free from oil and grease.
- **Disconnect the tool** when not in use, before servicing and when changing accessories such as blades, bits and cutters.
- **Remove adjusting keys and wrenches.** Form the habit of checking to see that keys and adjusting wrenches are removed from the tool and replaced in the storage area before switching on.
- **Avoid unintentional starting.** Do not carry a plugged-in tool with a finger on the switch. Ensure the switch is off when plugging in.
- **Use an outdoor extension cord.** When a tool is used outdoors, only use an extension cord intended for outdoor use and so marked.
- **Stay alert.** Watch what you are doing, use common sense and do not operate the tool when tired.
- **Check damaged parts.** Before further use of the tool, a guard or other part that is damaged should be carefully checked to determine whether it will operate properly and perform its intended function. Check for alignment of moving parts, free running of moving parts, breakage of parts, mounting and any other conditions that may affect its operation. A guard or other part that is damaged should be properly repaired or replaced by an authorised service centre unless otherwise indicated in the product booklet. Have defective switches replaced by an authorised service agent. Do not use the tool if the switch does not turn it on and off.
- **Warning!** The use of any accessory or attachment, other than recommended in the product booklet, may present a risk of personal injury.
- **Have the tool repaired by a qualified person.** The electrical tool is in accordance with the relevant safety requirements. Repairs should only be carried out by qualified persons using original spare parts, otherwise, this may result in considerable danger to the user.

## ADDITIONAL PRECAUTIONS TO TAKE WHEN SANDING PAINT AND MEDIUM DENSITY FIBREBOARD (MDF)

Sanding of lead based paint is **not recommended** due to the difficulty of controlling the contaminated dust. The greatest danger of lead poisoning is to children and pregnant women.



# ENGLISH

Any pre-1960 building may have been painted in the past with paint containing lead, and covered by additional layers of paint. It is important to determine whether the paint that is being sanded contains lead before beginning work. This can be done with lead test kits or by a professional decorator.

If in doubt, we recommend the following precautions when sanding any paint or MDF.

### PERSONAL SAFETY

No children or pregnant women should enter the work area where the paint sanding is being done until all cleaning up has been completed.

A dust mask or respirator should be worn by all persons entering the work area. The filter should be replaced daily or whenever the wearer has difficulty breathing.

**Note:** Only those dust masks suitable for working with lead paint dust and fumes should be used. Ordinary paint masks do not offer this protection.

No eating, drinking or smoking should be done in the work area to prevent ingesting paint particles. Workers should wash and clean up **before** eating, drinking or smoking. Articles of food ,drink etc., should not be left in the work area where dust could settle on them.

### ENVIRONMENTAL SAFETY

Paint should be removed in such a manner as to minimise the amount of dust generated

Areas where paint removal is occurring should be sealed with plastic sheeting.

Sanding should be done in a manner to reduce tracking of paint dust outside the work area.

### CLEANING AND DISPOSAL

All surfaces in the work area should be vacuumed and thoroughly cleaned daily for the duration of the sanding project. Vacuum filter bags should be changed frequently. Items of clothing, dust sheets, toys, washable furniture and utensils should be washed thoroughly before being used again.

**Save these instructions!**

### DOUBLE INSULATION



The tool is double insulated. This means that all the external metal parts are electrically insulated from the mains power supply. This is done by placing insulation barriers between the electrical and mechanical components making it unnecessary for the tool to be earthed.

**Note:** Double insulation does not take the place of normal safety precautions when operating the tool. The insulation system is for added protection

against injury resulting from a possible electrical insulation failure within the tool.

### ELECTRICAL SAFETY

Be sure the supply is the same as the voltage given on the rating plate. The tool is fitted with a two-core cable and plug.

### MAINS PLUG REPLACEMENT (UK ONLY)

Should the mains plug need replacing and you are competent to do this, proceed as instructed below. If you are in doubt, contact a Black & Decker service agent or a qualified electrician.

- Disconnect the plug from the power supply.
- Cut off the plug and dispose of safely. A plug with bared copper conductors is very dangerous if engaged in a live socket outlet.
- Only fit BS1363A approved plugs fitted with the correctly rated fuse. **Note:** Fuses do not give personal protection against electric shock.
- The cable wire colours, or a letter, will be marked at the connection point of most good quality plugs. Attach the wires to their respective points in the plug (see diagram). Brown is L (live) and blue is N (neutral).

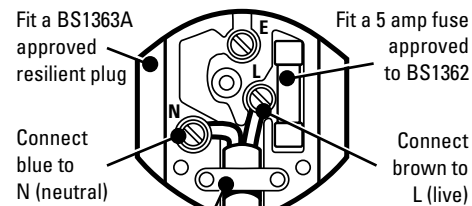

Make sure that the outer sheath of the cable is held firmly by the clamp



230 volts AC only  
Never use a light socket

- Before replacing the top cover of the plug ensure that the cable restraint is holding the outer sheath of the cable firmly and that the two leads are correctly fixed at the terminal screws. If the fuse cover is missing or damaged do not use the plug. For replacement or detachable fuse covers, contact a Black & Decker service agent.

**Warning!** Never connect live or neutral wires to the earth pin marked E or  $\perp$ .

### MAINS PLUG REPLACEMENT (AUSTRALIA AND NEW ZEALAND ONLY)

Should the mains plug or cordset of the product be damaged, it must only be replaced by an authorised





# ENGLISH

Black & Decker service agent because special purpose tools are required.

### EXTENSION CABLES

Up to 30m (100ft) of 3-core extension cable can be used without undue loss of power. **Note:** An extension cable should not be used unless absolutely necessary. Use of an improper extension cable could result in a risk of fire and electric shock. If an extension cable must be used, make sure it is properly wired, contains the correct rated fuse as recommended in its literature and is in good electrical condition.

### UNWANTED TOOLS AND THE ENVIRONMENT



Should you find one day that the tool needs replacement or is of no further use, think of the protection of the environment. Black & Decker service agents will accept old tools and will dispose of them in an environmentally safe way.

### THE BLACK & DECKER GUARANTEE (UK, AUSTRALIA AND NEW ZEALAND ONLY)

If the Black & Decker product becomes defective due to faulty materials and workmanship, within 24 months from the date of purchase, we guarantee to either replace all defective parts or at our discretion, replace the unit free of charge provided that:

- The product is returned to us or our authorised repairers with evidence of date of purchase.
- The product has not been used for trade, professional or hire purposes.
- The product has not been subjected to misuse or neglect.
- The product has not sustained any damage through foreign objects, substances or accidents.
- Repairs have not been attempted by anyone other than our authorised repair agents.

This guarantee is offered as an extra benefit and is additional to the customers statutory rights.

### AFTER SALES SERVICE FOR YOUR BLACK & DECKER PRODUCT (UK, AUSTRALIA AND NEW ZEALAND ONLY)

Black & Decker offers a nationwide network of authorised service agents. The use of other than genuine Black & Decker accessories and parts may damage or reduce the performance of your Black & Decker product and may also endanger the user. The terms and conditions of the warranty may also be effected.

### OUR AFTER SALES SERVICE POLICY (UK, AUSTRALIA AND NEW ZEALAND ONLY)

It is our aim that all Black & Decker customers should be totally satisfied with their Black & Decker product

and after sales service, but if help or advice is needed please contact your local Black & Decker authorised repair agent who will be happy to help. Full details of our after sales service and a list of these agents can be found on the Internet at [www.2helpU.com](http://www.2helpU.com). Alternatively, call our Service and Information Centre whose number you will find towards the back of this manual.

### ACCESSORIES

The performance of any power tool is dependant upon the accessory used. Black & Decker accessories are engineered to high quality standards and are designed to enhance the performance of your tool. Buying a Black & Decker accessory will ensure that you get the very best from your Black & Decker tool.

### TECHNICAL DATA

The level of sound pressure of the tool is in accordance with EEC legislation. It is recommended that you take appropriate measures for the protection of your hearing if the sound level seems uncomfortable. This normally equates to a sound pressure in excess of 85dB (A).

### FEATURES

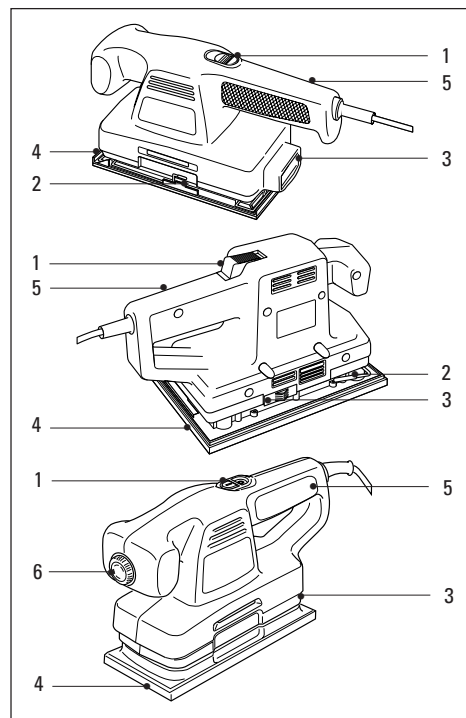



# ENGLISH

1. On/off switch
2. Paper clamp
3. Dust extraction
4. Sander base
5. Handle
6. Variable speed control

Your product includes some or all of these features.

**Note:** This user manual also covers more than one catalogue number within this product group. Refer to your carton for details of your product.

## PREPARING YOUR SANDER

To prepare your sander, proceed as follows:  
Disconnect the plug from the electricity supply.  
Fit the correct grade of sandpaper to the base of your sander. Connect the dust extraction outlet to a vacuum cleaner or fit the dust extraction bag (KA273).  
Set the variable speed control to the desired setting (KA185E/KA186E).

## FITTING THE SANDPAPER

Your sander uses one third sheet (CD400/KA175/KA180/KA185/KA185E), or pre-cut punched nylon backed sheets (KA186/KA186E/374455), or half sheet (KA273) of sandpaper. To fit the sandpaper, proceed as follows:  
Disconnect the plug from the electricity supply.

### KA186/KA186E/374455

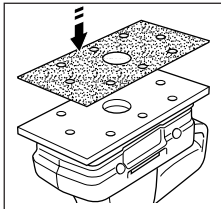

Press the nylon loop side of the abrasive sheet against the hooks on the base, making sure the holes of the paper and the base are aligned.

### CD400/KA175/KA180/KA185/KA185E

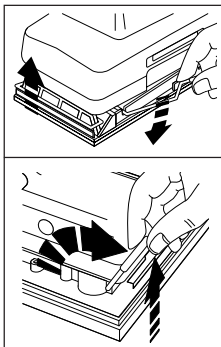

Press the handles of the front and rear paper clamps upwards, to release them from their retaining grooves.

Operate the paper clamp levers to open the paper clamps (KA273).

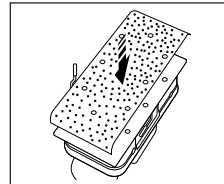

Align the holes in the sandpaper with the dust extraction holes in the base of your sander.

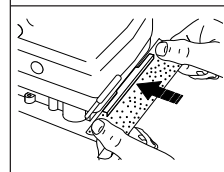
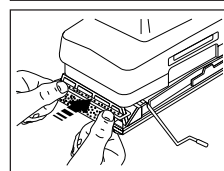
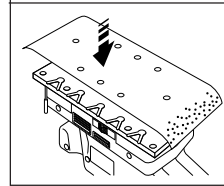

Hold the sandpaper in position and insert the edge of the sandpaper under the front paper clamp. Press the handle of the paper clamp downwards and locate it in the retaining groove (CD400/KA175/KA180/KA185/KA185E). Operate the front paper clamp lever to close the paper clamp (KA273). Keeping a

slight tension on the sandpaper, to adhere it to the base, insert the rear edge in the rear paper clamp. Press the handle of the paper clamp downwards and locate it in the retaining groove (CD400/KA175/KA180/KA185/KA185E). Operate the rear paper clamp lever to close the paper clamp (KA273).

## DUST EXTRACTION (CD400/KA175/KA180/KA185/KA185E/KA186/KA186E/374455)

Your sander has an adaptor to connect it to a vacuum cleaner. To connect the vacuum cleaner, proceed as follows:

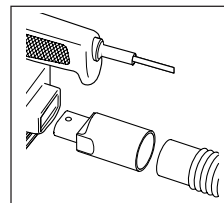

Insert the adaptor in the rear outlet of your sander and connect the hose of the vacuum cleaner.

## DUST EXTRACTION (KA273)

Your sander has an external bag for the collection of dust. To fit the dust extraction bag, proceed as follows:





## ENGLISH

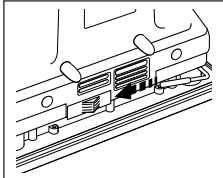

Slide the cover of the dust extraction outlet forward and insert the nozzle of the dust extraction bag in the aperture. To empty the dust extraction bag, open the zip fastener and empty the contents. To remove the dust extraction bag, depress the release catch and remove the bag from the aperture.

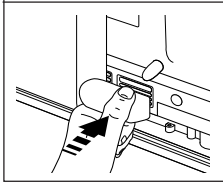

### VARIABLE SPEED (KA185E/KA186E)

The variable speed control on the front of your sander gives the optimum speed for every material.

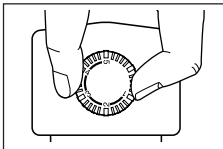

To adjust the speed of your sander, set the control knob to the desired number.

Suggested speeds are given in the following table:

Material	Electronic level
Hardwood (beech)	3-5
Softwood (pine)	3-5
Veneer wood	2-4
Synthetic material	3-4
Acrylic glass	2-5
Non-ferrous metal	2-5
Steel	2-5
Lacquer removal	3-5

### OPERATING YOUR SANDER CD400/KA175/KA273

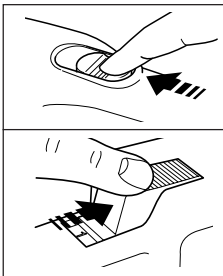

To switch your sander on, slide the on/off switch forward; the mark "1" appears.

To switch your sander off, slide the on/off switch to the rear; the mark "0" appears.

### KA180/KA185/KA185E/KA186/KA186E/374455

To switch your sander on, press the switch marked "1". To switch your sander off, press the switch marked "0".

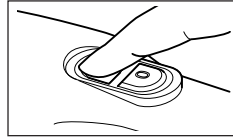

### HANDY HINTS

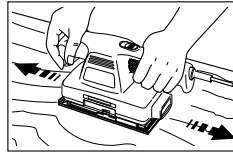

Always hold your sander with two hands. Always sand with the grain of the wood. If you sand across the grain, you will leave swirl marks.

- Use the correct grade of sandpaper. Low grit sandpapers give a high stock removal rate, with a coarse finish. High grit sandpapers give a low stock removal rate, with a finer finish. As a general rule, start with the low grit paper and finish with the higher grit.
- Replace worn sandpaper.
- Empty the dustbag (KA273) every 10 minutes.
- Set the correct speed (KA185E/KA186E). Use low speed for acrylics and synthetics and use medium or high speed for hard and soft wood.

### TOOL CARE

- Do not apply excessive pressure on your sander. This can cause your sander to overheat. If your sander becomes too hot, operate it off-load for 2 minutes.
- Always keep the air cooling vents on the motor housing clear.
- To clean your sander, proceed as follows:
- Disconnect the plug from the electricity supply.
- Use a clean dry paint brush to clear vents and ducts.
- Clean the housing using a clean damp cloth (do not use solvents, petrol or turpentine).

### EC DECLARATION OF CONFORMITY

We declare that units: **CD400, KA175, KA180, KA185, KA186, KA273, 374455** conform to 89/392/EEC, 89/336/EEC, EN55014, 73/23/EEC, EN55104, EN50144  
A weighted sound pressure 85dB (A)  
A weighted sound power 98dB (A)  
Hand/arm weighted vibration 4.6m/s<sup>2</sup>

*Brian Cooke*

Brian Cooke - Director of Engineering  
Black & Decker, Spennymoor, Co Durham DL16 6JG UK  
The Black & Decker policy is one of continuous improvement to our product and as such we reserve the right to change the product specification without prior notice.







<b>Australia</b>	DeWalt Industrial Power Tool Company (Distributors of Black & Decker products) 7 Clarice Road, Box Hill, Victoria 3128	Tel: 03 9895 9200 Fax: 03 9899 7465
<b>New Zealand</b>	Black & Decker 483 Great South Road Penrose, Auckland	Tel: 09 579 7600 Fax: 09 579 8200
<b>South Africa</b>	Black & Decker South Africa (Pty) Ltd Suite no 107, PostNet X65 Halfway House 1685	Tel: 011 314 4431 Fax: 011 314 4435
<b>United Kingdom</b>	Black & Decker 210 Bath Road, Slough Berkshire SL1 3YD	Tel: 01753 574277 Tlx: 848317 BAND MH Fax: 01753 551155

Part no: 373340-40 10/99



# GUARANTEE CARD

## AUSTRALIA/NEW ZEALAND 2 YEAR REPAIR GUARANTEE

Black & Decker welcomes you as a purchaser of this product from our range of Home Workshop and Garden Tools and Accessories. All our products are engineered and manufactured to ensure the highest standards of reliability and performance during use, and are supported in After Sales Service by a wide network of Black & Decker Authorised Service Centres.

### BLACK & DECKER SUPPLEMENTARY GUARANTEE

Subject to the conditions stated below, Black & Decker guarantees that it will correct by repair or parts replacement, without charge, any defect in the product which this Guarantee Card accompanies ("Product") arising from faulty workmanship or materials where such defect arises within two years from the date of purchase of the product. A product subject to claim under this guarantee should be returned as a complete unit to the most convenient Black & Decker Authorised Service Centre or Agent.

### CONDITIONS

The Black & Decker Supplementary Guarantee does not apply in the following cases:

- where the product has been used for trade or industrial purposes;
- where any defect or failure is attributed to accident, misuse, abuse, negligence or non-observance of local regulations on the part of the owner or user; or
- where the product has been serviced by a person not authorised by Black & Decker to do so, or with non-approved parts; or
- to loose accessories.

In order to enforce the Black & Decker Supplementary Guarantee, proof of purchase is required (Guarantee Card and or store receipt). The period of the Black & Decker Supplementary Guarantee begins

from the original date of purchase notwithstanding any subsequent repair or parts replacement. No Guarantees other than contained in this document, whether written or verbal, are authorised to be made on behalf of Black & Decker. All other conditions and guarantees whether expressed or implied by law, are, to the extent permitted by law, hereby excluded. **The Black & Decker Supplementary Guarantee does not apply outside Australia and New Zealand.**

### PURCHASERS' STATUTORY RIGHTS

The Black & Decker Supplementary Guarantee set out above does not exclude any conditions or guarantees that may be mandatorily implied by law, and your attention is drawn to the provisions of the Consumer Guarantee Act 1993 (New Zealand only), Trade Practices Act 1974 and State legislation (Australia only), which confers rights upon consumers. The Black & Decker Supplementary Guarantee is in addition to any rights conferred on a consumer under the Act, where applicable, and any other rights provided under applicable legislation.

### WARRANTY REGISTRATION

NAME: \_\_\_\_\_

ADDRESS: \_\_\_\_\_

PHONE: \_\_\_\_\_ POST CODE: \_\_\_\_\_

Catalogue number: \_\_\_\_\_ Description: \_\_\_\_\_

Date of purchase: \_\_\_\_\_ Retailer's name: \_\_\_\_\_

# RETAIN THIS CARD



**AUSTRALIA/NEW ZEALAND** Part No: 763838



**DO NOT MAIL THIS CARD TO BLACK & DECKER. RETAIN THIS CARD IN CASE OF A CLAIM.**

**UPON PURCHASE**

Fill in the Warranty Registration Section of the card and attach your purchase receipt to the top corner of the card. Retain in case of claims in the future.

**MAKING A CLAIM**

Take your defective product together with the Warranty Registration Card and purchase receipt to your local Service Centre. You can either do this in person or send freight prepaid. If mailing or shipping your appliance, ensure to remove any liquids from the product (if applicable) and pack it carefully in a sturdy carton with enough packing material to prevent damage. Include a note describing the problem to the Service Centre and be sure to give your telephone number and return address.



**ATTACH  
RECEIPT HERE**

**AUSTRALIA**

DeWalt Power Tool Company  
(Distributors of Black & Decker products)  
7 Clarice Road, Box Hill  
Victoria, 3128

**For Service**

See "Electric Tools-Retail and/or Repairs" section of Yellow Pages for Service & Sales, otherwise Head Office (09) 9213 8200



**NEW ZEALAND**

Black & Decker (New Zealand) Limited  
Consumer Home Workshop & Garden Tools  
Product Service Division,  
PO Box 12-135  
Penrose, Auckland

**For your local Authorised Service Centre**

Please contact your retailer or Black & Decker (NZ) Limited  
483 Great South Road  
Penrose, Auckland  
Ph:(09) 579 7600  
Fax:(09) 525 1975



Part no: 373340-40 10/99

